

ST121-KI1TA.03

Temperature controller

Order number 267856



Wiring diagram

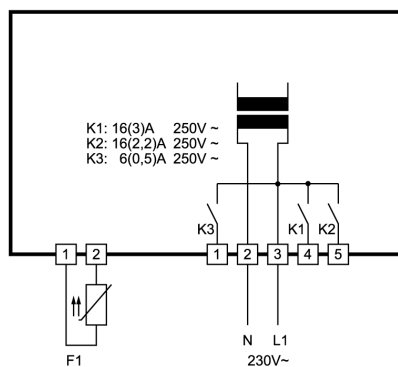

Product description

The switching outputs of the thermostatic controller can be programmed as

- two-point controller with alarm
- three-point controller with alarm contact
- two-stage controller with alarm contact
- three-stage controller.

Beside the standby key there is a further key to set functions, which can be variously parametered.

Sensor: multi resistance input

Range: dependent on type of sensor

Front size: 120mm x 42mm

Panel cut-out: 102,5mm x 35mm

Tightness: front IP65

Connector: screw terminal

ST 121...

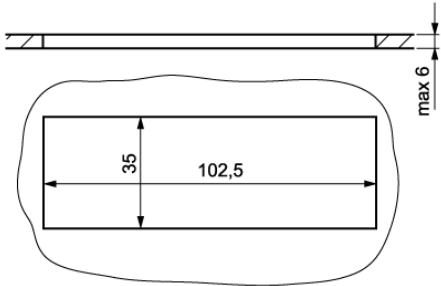
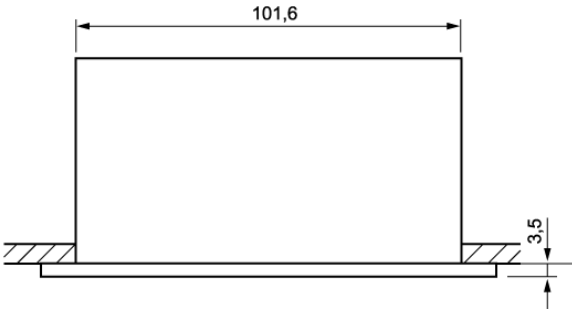
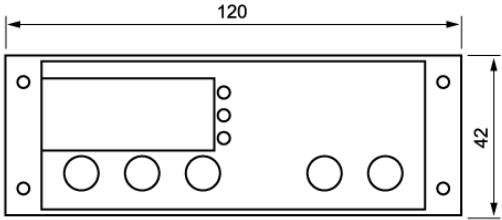

SOFTWARE .03

Adjustment options



Key 1: UP

Pressing this key you can increase the parameter or parameter value or scroll the parameter list.



Key 2: DOWN

Pressing this key you can decrease the parameter or parameter value or scroll the parameter list. At alarm the buzzer function can be switched off with this key.



Key 4: SET

While SET key is pressed, the setpoint is indicated. In addition, the SET key is used for setting parameters



Key 3: A

Different functions are assigned to this key by help of parameters, see parameter A85. The key has to be pressed for at least half a second.



Key 5: Standby

Pressing this key switches the controller to standby mode.

First control level:

Parameter setting of the control setpoint

If none of the keys is pressed, the display indicates the actual value of the temperature. Pressing the SET key, the setpoint shows on the display.

If the setpoint is to be changed, the SET key is to be kept pressed while adjusting the setpoint with the keys UP and DOWN.

Please note that the setpoint can only be changed within the set setpoint limits.

Parameter	Function description	Adjustment range	Standard setting	Custom setting
S1	Setpoint	P4...P5	0.0°C	

The setpoint of control contact 2 can be adjusted in the second control level (parameter P1) or directly with key 4 or 5, if accordingly parametered (A85 and/or A86).

Second control level (P parameters):

Setting of control parameters

Simultaneously pressing the UP and DOWN key for at least 4 seconds opens a parameter list containing control parameters.

With the UP and DOWN keys the list can be scrolled in both directions.

Pressing the SET key will give you the value of the respective parameter. Pressing also the UP or DOWN key at the same time the value can be adjusted.

Return to the initial position takes place automatically, if no key is pressed for 60 seconds.

Parameter	Function description	Adjustment range	Standard setting	Custom setting
P0	Actual value	-		
P1	Setpoint or DeltaW	P4...P5 -99...99.9 K	10.0°C/K	
P2	Hysteresis contact K1	0.1... 99.0 K	1.0 K	
P3	Hysteresis contact K2	0.1... 99.0 K	1.0 K	
P4	Control range limitation – minimum setpoint	-99°C...P5	-99°C	
P5	Control range limitation – maximum setpoint	P4...999°C	999°C	
P6	Actual value correction	-20,0...+20,0 K	0,0 K	
P19	Key-lock	0: no key-lock 1: key-lock	0	
P30	Lower alarm value	-99 ... 999°C/K	-99°C	
P31	Upper alarm value	-99 ... 999°C/K	100°C	
P32	Hysteresis alarm circuit	0.1... 99.9 K	1.0 K	

Parameter description:

P0: Actual value

The here indicated temperature presents the actual measured value. If the control setpoint is indicated by the help of parameter A32, the actual value can only be seen with this parameter.

P1: Setpoint / DeltaW for control circuit 2

Adjusting the setpoint of control circuit 2.

If A5=1, the setpoints for control circuit 1 and 2 are linked with one another via switching difference DeltaW, which can be adjusted with P1. (operation with DeltaW)

The following applies: setpoint thermostat 2 = setpoint control circuit 1 + delta W2.

This difference can take positive or negative values. Thus, a leading or following contact can be realised.

P2: Hysteresis contact K1

P3: Hysteresis contact K2

The hysteresis can be set symmetrically or one-sided at the setpoint (see A40, A41).

At one-sided setting, the hysteresis works downward with heating contact and upward with cooling contact. At symmetrical hysteresis, half of the hysteresis' value is effective below and half of the value above the switching point (see fig. 1 and 2).

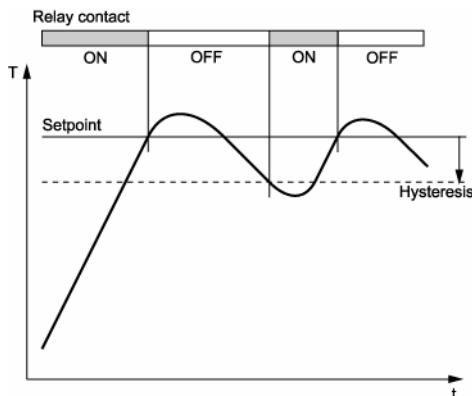

Fig. 1: Heating controller, one-sided hysteresis hysteresis

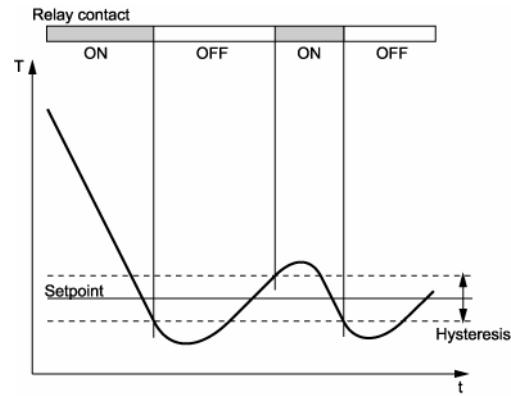

Fig. 2: Cooling controller, symmetrical hysteresis

P4: Control range limitation – minimum setpoint

P5: Control range limitation – maximum setpoint

The adjustment range of the setpoint can be limited in both directions. This is to prevent the end user of a unit from setting inadmissible or dangerous setpoints.

P6: Actual value correction

This parameter allows the correction of actual value deviations caused for example by sensor tolerances or extremely long sensor lines. The regulation measure value is increased or decreased by the here adjusted value.

P19: Key-lock

The key-lock allows blocking of the control keys. In locked condition parameter adjustments with keys is not possible. At the attempt to adjust the parameters despite key-lock the message "====" appears in the display.

P30: Lower alarm value

P31: Upper alarm value

The exit alarm is a boundary alarm or a range alarm with one-sided hysteresis (see parameter P32). Both at the boundary alarm and the range alarm, limit values can be relative, i.e. going along with the setpoint S1, or absolute, i.e. independent of the setpoint S1. At boundary alarm the hysteresis works one-sided inwardly, and at range alarm outwardly (see fig. 3-6).

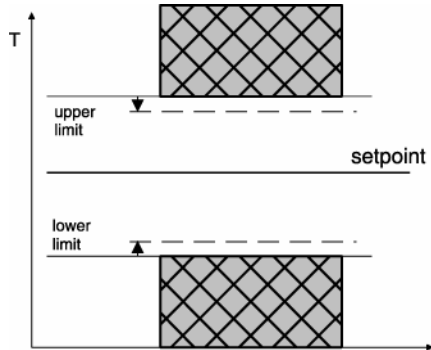

Fig. 3: Boundary alarm, alarm contact normal
 A30=0 limits relative
 A30=1 limits absolute

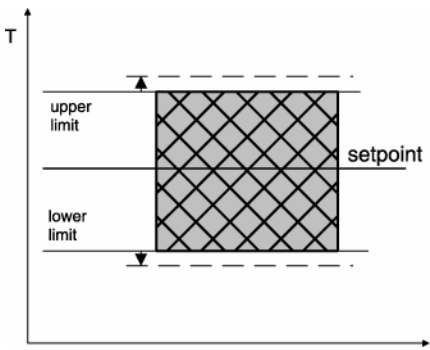

Fig. 4: Range alarm, alarm contact normal
 A30=2 limits relative
 A30=3 limits absolute

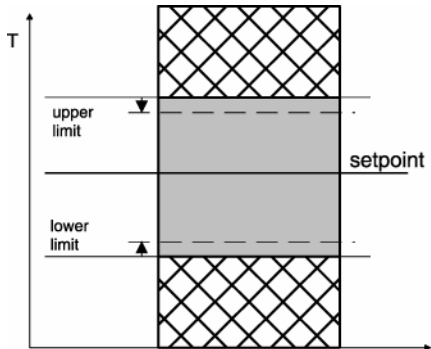

Fig. 5: Boundary alarm, alarm contact invers
 A30=4 limits relative
 A30=5 limits absolute

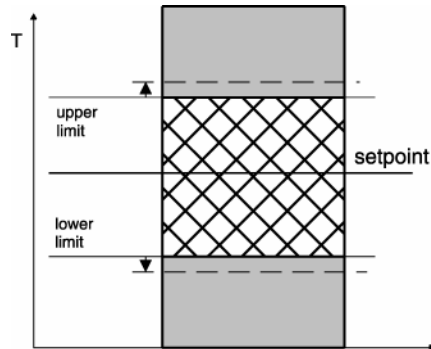
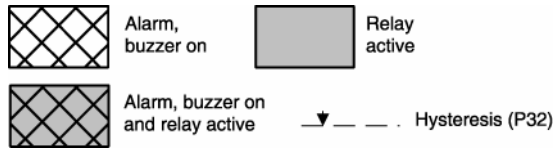

Fig. 6: Range alarm, alarm contact invers
 A30=6 limits relative
 A30=7 limits absolute



P32: Hysteresis alarm circuit

Hysteresis is set one-sided at the adjusted limit value. It becomes effective depending on alarm definition (see fig. 3-6).

Third control level, (A parameters):

Setting of control parameters

Access to the third control level is granted when selecting the last P-parameter on the second control level. Continue to press the UP key for approximately 10 seconds until "PA" appears. Continue to press the UP key and additionally press the DOWN key for about 4 seconds and the first A-parameter of the third control level is indicated.

With the keys UP and DOWN you can scroll the list in both directions. Pressing the SET key will give you the value of the respective parameter. By pressing the UP or DOWN key at the same time the value can be adjusted.

Return to the initial position takes place automatically, if no key is pressed for 60 seconds, or by simultaneously pressing the UP and DOWN key for approx. 4 seconds.

Parameter	Function description	Adjustment range	Standard setting	Custom setting
A1	Switch mode contact K1	0: heating contact 1: cooling contact	0	
A2	Switch mode contact K2	0: heating contact 1: cooling contact	1	
A3	Function of contact K1 at sensor error	0: relay off 1: relay on	0	
A4	Function of contact K2 at sensor error	0: relay off 1: relay on	0	
A5	Selection setpoint 2 or DeltaW	0: operation with setpoint 2 1: operation with DeltaW	1	
A8	Display mode (all parameter indications are presented in 0,1°K)	0: integrals 1: decimals in 0.5°C 2: decimals in 0.1°C	1	
A9	Weighing factor	0.50 ... 1.50	1.00	
A19	Parameter lock	0: no lock 1: A-parameter locked 2: A- and P-parameter locked	0	
A30	Function alarm exit	0: Boundary alarm, relative 1: Boundary alarm, absolute 2: Range alarm, relative 3: Range alarm, absolute 4: Boundary alarm, relative, alarm contact inverted 5: Boundary alarm, absolute, alarm contact inverted 6: Range alarm, relative, alarm contact inverted 7: Range alarm, absolute, alarm contact inverted	0	
A31	Special function at boundary or range alarm	0: no special function 1: flashing display 2: buzzer 3: flashing display and buzzer 4: like 3, buzzer can be cancelled 5: like 4, buzzer restarts after 10 min. 6: like 4, buzzer restarts after 30 min	0	
A32	Setpoint display	0: display shows actual value 1: display shows setpoint S1	0	

Parameter	Function description	Adjustment range	Standard setting	Custom setting
A40	Hysteresis mode contact K1	0: symmetrically 1: one-sided	1	
A41	Hysteresis mode contact K2	0: symmetrically 1: one-sided	1	
A50	Minimum action time contact K1 "On"	0...600 sec.	0 sec.	
A51	Minimum action time contact K1 "Off"	0...600 sec.	0 sec.	
A52	Minimum action time contact K2 "On"	0...600 sec.	0 sec.	
A53	Minimum action time contact K2 "Off"	0...600 sec.	0 sec.	
A54	Delay after "Power-on"	0...600 sec.	0 sec.	
A55	Mutual delay of contacts K1 and K2	0...600 sec.	0 sec.	
A56	Alarm suppression after "Power-On"	0...60 min.	30 min.	
A60	Sensor type	11: PT100 two-wire 21: PTC 22: PT1000 two-wire	11	
A70	Software filter	1: inactive 2...32: average value with 2...32 measuring values	4	
A80	Temperature scale and display when in Standby-Mode	0: Fahrenheit ("AUS") 1: Celsius ("AUS") 2: Fahrenheit ("OFF") 3: Celsius ("OFF")	1	
A85	Function key A	0: no function 1: indicates actual value (if A32=1) 2: setpoint P1 3: switching a relay selected by A90-92, relay switched off in standby mode 4: switching a relay selected by A90-92, relay independent of standby mode	0	
A86	Function key B	see A85	0	
A90	Output connection relay K1	0: no connection 1: connection to contact K1 2: connection to contact K2 3: connection to alarm contact 4: connection to key A or B 5: connection to buzzer 6: connection, if unit switched on	1	
A91	Output connection relay K2	see A90	2	
A92	Output connection relay K3	see A90	3	
Pro	Program version	-	-	

Parameter description:

The following values can change the equipment characteristics and are therefore to be set with utmost care.

A1: Switch mode contact K1

A2: Switch mode contact K2

The switch mode for the relays, i.e. cooling or heating function, can be programmed independently at works. Heating function means that the contact opens as soon as the setpoint is reached, thus power interruption. At cooling function the contact closes, if the actual value is above the required setpoint. (see fig. 1 + 2)

A3: Function of contact K1 at sensor error

A4: Function of contact K2 at sensor error

At sensor error the selected relay falls back into the condition pre-set here. If there is a data-loss in parameter memory (display indicates "EP") both contacts K1 and K2 are switched off.

A5: Selection setpoint 2 or DeltaW

This parameter determines whether the setpoints for thermostat 1 and 2 independently adjustable (A5=0) or whether they are tied with one another via a switching offset DeltaW (A5=1). This parameter applies only to contact K2 (see parameter P1).

A8: Display mode

The value can be indicated in integrals or with decimals in 0,5°K or 0,1°K. At indication in 0,5°K the value is rounded up or down. In general, all parameter indications are presented in 0,1°K.

A9: Weighing factor

With this parameter the actual value can be submitted to weighing. The measured value is multiplied by it and both indicated in the display and applied for regulation.

A19: Parameter lock

This parameter enables locking of each parameter level. If third level is locked, only parameter A19 may be changed.

A30: Function alarm exit

The alarm exit evaluates an upper and a lower limit value (see parameters P30 and P31), whereas a selection is possible as to whether the alarm is active if the temperature lies within these two limits, or whether the alarm is released if the temperature lies beyond them. In the case of sensor error, the alarm is activated independently of this adjustment. The exit can also be inverted, so that it functions like a release (see fig. 3 – 6 at parameters P30/31).

A31: Special function at boundary or range alarm

Here can be selected whether, in the case of an alarm, the indication to flash and/or the buzzer is to start. Sensor alarm (display F1L or F1H) is indicated independently thereof by flashing display and the buzzer.

A32: Setpoint display

A32=0 indicates the actual value, A32=1 statically indicates the setpoint S1 in the display. Therefore, the current actual value can only be indicated with parameter P0.

A40: Hysteresis mode contact K1

A41: Hysteresis mode contact K2

These parameters allow selection as to whether the hysteresis values which are adjustable with P32, are set symmetrically or one-sided at the respective switching point. At symmetrical hysteresis, half of the hysteresis' value is effective below and half of the value above the switching

point. The one-sided hysteresis works downward with heating contact and upward with cooling contact (see fig. 1 + 2).

A50: Minimum action time contact K1 "On"

A51: Minimum action time contact K1 "Off"

A52: Minimum action time contact K2 "On"

A53: Minimum action time contact K2 "Off"

These parameters permit a delay in switching on/off the relay in order to reduce the switching frequency. The adjusted time sets the entire minimum time period for a switching-on or switching-off phase.

A54: Delay after "Power-on"

This parameter allows a switching-on delay of relays after switching-on the mains voltage. This delay corresponds with the time set here.

A55: Mutual delay of contacts K1 and K2

This parameter makes a mutual switching-on delay of relays possible, depending on whichever contact is switched first.

A56: Alarm suppression after "Power-On"

This parameter allows a switching-on delay of the alarm contact after switching on the mains voltage or setpoint change-over. This delay corresponds with the time set here.

A60: Sensor type

This parameter permits selection of the sensor type, if the needed hardware prerequisites are available.

A70: Software filter

With several measuring values, it is possible to obtain an average value. This parameter can determine by how many measured values an average value is to be formed. If a sensor with a very fast reaction to external influences is used, an average value ensures a calm signal process.

A80: Temperature scale

Indication can be switched between Fahrenheit and Celsius. At conversion, the parameters and setpoints maintain their numerical value and adjustment range. (Example: A controller with the desired value of 0°C is switched to Fahrenheit. The new desired value is then interpreted as 0°F, which corresponds to a temperature of -18°C).

NOTE: Indication limits with °F can be smaller than the actual measuring range!

A85: Function „key A“

A86: Function „key B“ (if available)

The following functions are available:

0: the respective key has no function

1: the controller indicates the actual value (if A32=1)

2: the key is linked with the function of parameter P1

3: a relay (indicated with parameter A90-92) can be switched on or off directly with the key.

In standby mode the key is locked and the corresponding relay switched off. After restarting the corresponding relay remains switched off

4: like 3, but the relay is switched despite of the standby mode.

A90: Output connection relay K1

A91: Output connection relay K2

A92: Output connection relay K3

Depending on existing hardware there may not be all output relays. This parameter assigns the respective relay to the internal controller outputs, to key A or B, to the alarm contact or the buzzer.

Status messages

Message	Cause	Error elimination
"AUS" or "OFF"	Standby modus, no regulation	Switch on by key or switching entrance
F1L	Sensor error, short-circuit at sensor F1	Check sensor
F1H	Sensor error, open-circuit at sensor F1	Check sensor
---	Key-lock active	Change parameter P19 or A19
display flashes	Temperature alarm at too high or too low temperature (if activated) see A31	
Buzzer	Temperature alarm at too high or too low temperature (if activated) see A31	The buzzer function can be switched off with the DOWN-key
EP, display flashes	Data loss at parameter memory (Contacts K1 and K2 are switched off)	If error cannot be eliminated by switching on/off, the controller must be repaired

Technical data of ST121-KI1TA.03

Measuring input

F1: Resistance sensor PTC, Pt100 or Pt1000, 2-wire connection
Measuring range: Pt100 -80°C...+400 °C
Pt1000 -99°C...+350°C
PTC -50°C...+150 °C

Measuring accuracy of the controller at 25°C: +/-0.5K und +/-0.5% of measuring range

Outputs

K1: Relay, normally-open contact, 20(3)A 250V~,
permanent current max. 16(3)A, limited by connectors and/or conductive strips
K2: Relay, normally-open contact, 16(2.2)A 250V~
K3: Relay, normally-open contact, 6(0.5)A 250V~

Please note: K1, K2 and K3 have a common and potential-afflicted connection.
The total current at terminal X2, Pin 3 may not exceed 16A!

Display

One 3-digit LED-Display, height 13 mm, colour red
3 LEDs, diameter 3mm, colour red, for status display of compressor, fan, defrost

Power supply

230V~ 50/60 Hz, power consumption max. 10 VA

Connectors

screw terminal

X1: 2 pole, spacing 5.0 mm, for cable up to 2.5 mm²
X2: 5 pole, spacing 5.0 mm, for cable up to 2.5 mm²

Ambient conditions:

Storage temperature: -20...+70°C
Operating temperature: 0...+55°C
Relative humidity: max. 75% without dew

Weight

ca. 300 g, without sensor

Enclosure

Front IP65, IP00 from back

Installation data

Front size: 120 x 42 mm
Panel cut-out: 102.5 x 35 mm
Installation depth: max. 47mm